

acer +





Acer+

De prestaciones y diseño vanguardista, ACER+ es una combinación de materiales nobles que conforman aristas perfectamente ordenadas. Resistente, confortable y duradero.





Sillón alto | S0000-12bb-xxyy

Referencia	Base	Ruedas	Brazos	Mecanismo
S0200	aluminio	cromo/goma	aluminio	basculante avanzado
S0201	aluminio	taponos	aluminio	sistema revolving
S0202	aluminio	cromo/goma	aluminio	elevación a gas

Unidades: 1 / Peso (Kg.): 20,30 / Volumen (m3): 0,25



Sillón bajo | S0000-12bb-xxyy

Referencia	Base	Ruedas	Brazos	Mecanismo
S0210	aluminio	cromo/goma	aluminio	basculante avanzado
S0211	aluminio	taponos	aluminio	sistema revolving
S0212	aluminio	cromo/goma	aluminio	elevación a gas

Unidades: 1 / Peso (Kg.): 19 / Volumen (m3): 0,18

Confidente | S0000-12bb-xxyy

Referencia	Patín	Brazos
S0220	cromo	aluminio

Unidades: 1 / Peso (Kg.): 15 / Volumen (m3): 0,20

Unidades: 2 / Peso (Kg.): 30 / Volumen (m3): 0,32



color malla (xx):	
1	blanco
2	negro
5	azul
6	naranja
12	plata
13	amarillo
18	rojo
22	gris
23	granate



FICHA TECNICA BÁSICA ACER+

Características:

De prestaciones y diseño vanguardista, ACER+ es una combinación de materiales nobles que conforman aristas perfectamente ordenadas para proporcionar ergonomía y funcionalidad. Resistente, confortable y duradera. Con posibilidad de sillón alto, bajo y confidente, es la colección ideal para armonizar espacios, con la solidez del acero y la ligereza de la malla.

Resumen materiales sillón alto y bajo:

Asiento monocarcasa: Estructura de doble tubo de 25 mm de diámetro de acero cromado con refuerzo interior de acero. Respaldo en malla técnica de alta resistencia.

Opcional: Funda acolchada rellena de látex y tapizada.

Mecanismo: Basculante avanzado 5 posiciones / Sistema revolving / Elevación a gas.

Brazos: Fijos de aluminio cromado.

Columna de gas: Elevación mediante columna de gas cromada.

Base: De aluminio pulido de 70 cm de diámetro.

Ruedas: Dobles engomadas en Desmopán de 50 mm de diámetro con cubre rueda cromado.

Opcional: Tapones antideslizantes de acero cromado.

Resumen materiales confidente:

Asiento monocarcasa: Estructura de tubo de acero cromado de 25 mm de diámetro con respaldo en malla técnica de alta resistencia.

Opcional: Funda acolchada rellena de látex y tapizada.

Brazos: Fijos de aluminio cromado.

Estructura: Tubo de acero cromado de 25 mm de diámetro.

Resumen tapizados:

Malla: ver ficha técnica de tapizados.

Listado de certificados y normativas:

UNE EN 1335/01, parte 2

UNE EN 1335-3/00, parte 7

UNE EN 1335-3/00, parte 9.2.2

UNI EN ISO 1421

EN ISO 4892-2/06

EN 1335 3/01

EN 12527/98 parte 4.12

UNE EN 1335-3/00, parte 5

UNE EN 1335-3/00, parte 9.1

UNI 9213/3

EN 1728/00

EN ISO 105-x12/03

UNI 9084/02

EN 12527/98 parte 4.13

UNE EN 1335-3/00, parte 6.1

UNE EN 1335-3/00, parte 9.2.1

UNI 1049/2

EN 15373/07

EN ISO 12947-2/98

ANSI-BIFMA X5.1-2011/7

EN 12527/98 parte 4.14

Cotas:

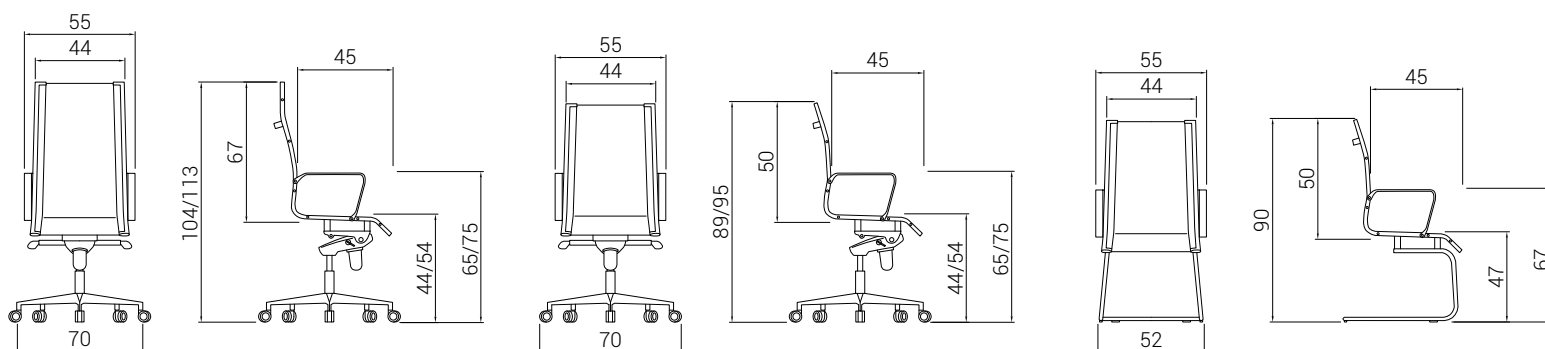

Tapizados / Grupo 1 / Bali



P5



P6



P7



P8



P16



P17



P19



P20



P21



P22



P23



P24



P28



P29



P30



P31



P32



P33

muestrarios

Tapizados / Grupo 1 / Poliéster

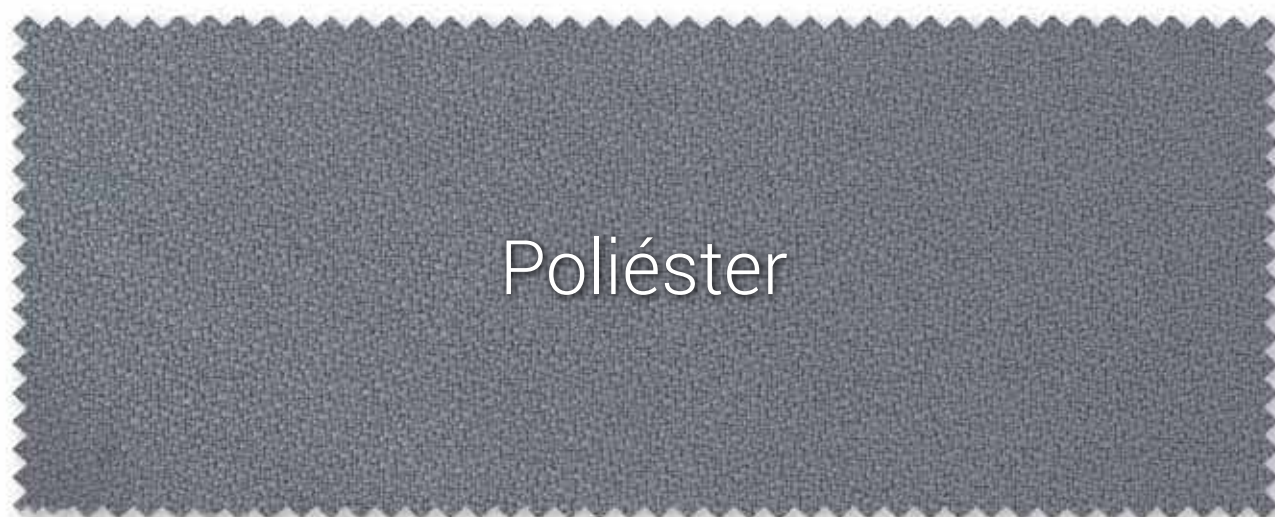

C1



C2



C3



C4



C5



C6



C7



C8



C9



C10



C11



C12



C13



C14



C16



C17

Tapizados / Grupo 1 / Goya



D1



D2



D3



D4

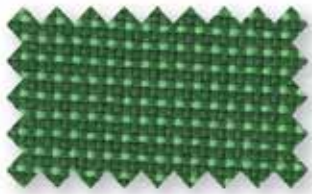

D5

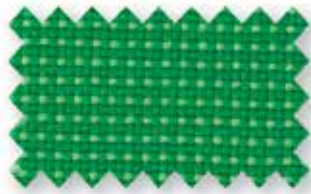

D6

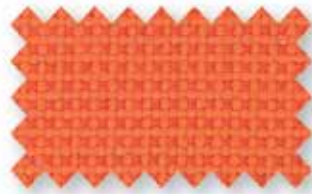

D8



D9



D10



D11



D12



D13

muestrarios

Tapizados / Grupo 1 / Touch Leather



R1



R2



R3



R4



R5



R6



R7



R8

Tapizados / Grupo 1 / Combi

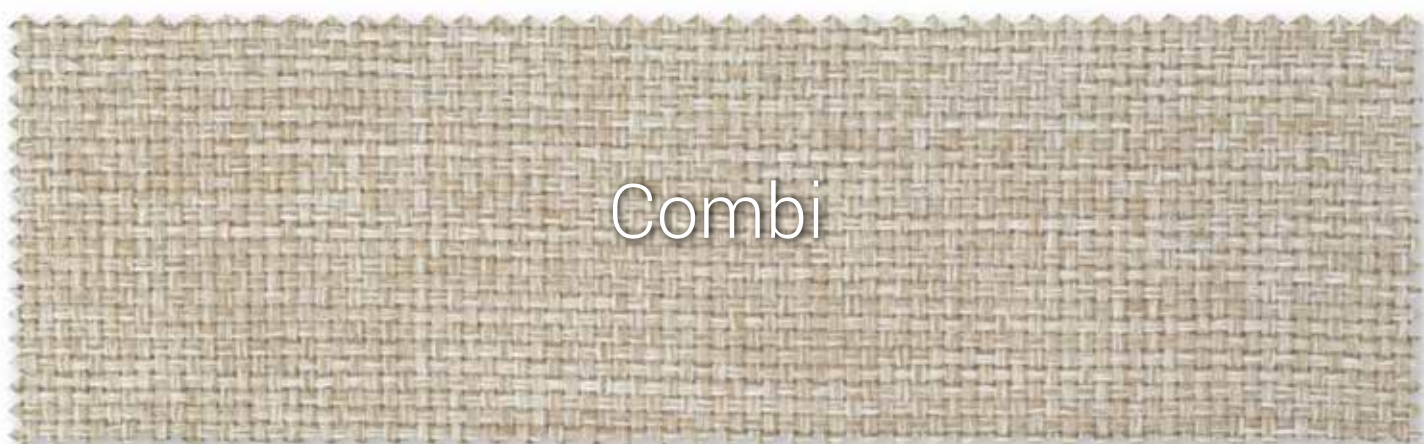

B1



B2



B3



B4



B5



B6



B7



B8

Tapizados / Grupo 2 / Madison



madison 1



madison 2



madison 3



madison 4



madison 5



madison 6



madison 7



madison 8



madison 9



madison 10



madison 11



madison 12



madison 13



madison 14



madison 15



madison 16



madison 17



madison 18



madison 19



madison 20

muestrarios

Tapizados / Grupo 2 / Ocean



G1



G2



G3



G4



G5



G6



G7



G8



G9

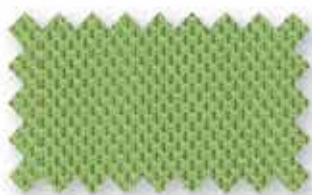

G10



G11



G12



G13

Tapizados / Grupo 2 / Elastika FR



11



12



13



14



15



16



17



18



19



110



111



112



113



114

muestrarios

Tapizados / Grupo 2 / Oruga



01



02



03



04



05



06



07



08



09



010



011



012



013



014



015



016

Tapizados / Grupo 2 / Nilo



NL1



NL2



NL3



NL4



NL5



NL6



NL7



NL8



NL9



NL10



NL11



NL12



NL13



NL14



NL15



NL16



NL17



NL18



NL19



NL20



NL21



NL22



NL23



NL24

muestrarios

Tapizados / Grupo 2 / Nilo



NL25



NL26



NL27



NL28



NL29



NL30



NL31



NL32



NL33



NL34



NL35



NL36



NL37



NL38



NL39



NL40



NL41



NL42



NL43



NL44



NL45



NL46



NL47

Tapizados / Grupo 4 / Piel



F1



F2



F3



F4



F5



F6



F7



F8



F9



F14



F15



F18



F25

muestrarios

Mallas / Acer+

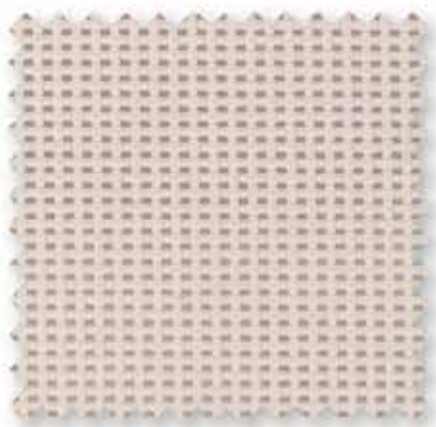

1



2



5



6

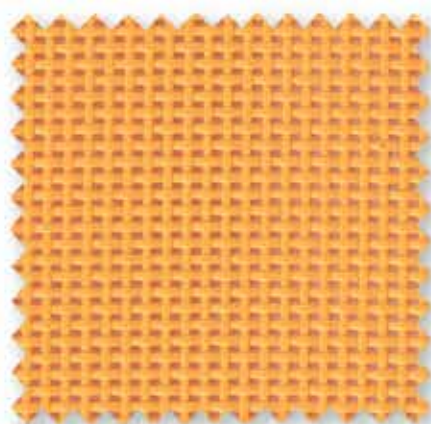

13



18



22

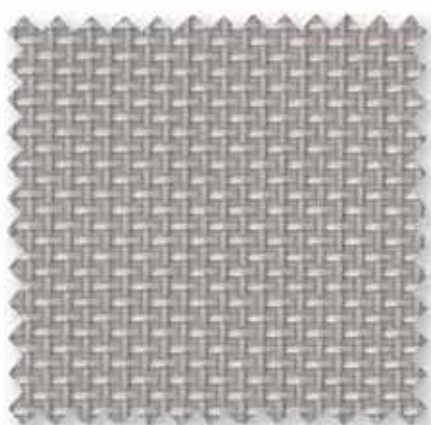

12



23

DILE THE ART OF SEATING

15 Aniversario



www.dileoffice.com

DILEOFFICE Showroom Madrid: C/ Marcelina, 6 28029 (Madrid)
DILEOFFICE S.L. Pol. Ind. II, Avda. de Valencia S/N, 03420 Castalla (Alicante) SPAIN

Tel. +34 965 561 177 | Fax. +34 965 560 672 | info@dileoffice.com

